

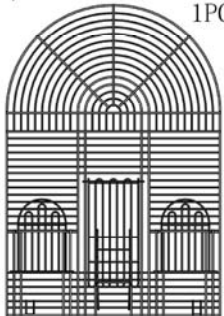

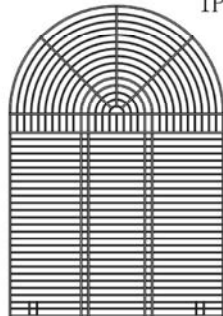

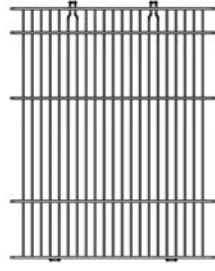



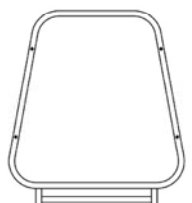

ASSEMBLY INSTRUCTIONS

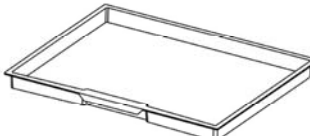
Item No. : 26486

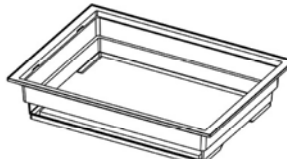
PART LIST

(A) FRONT PANEL 1PC 	(B) BACK PANEL 1PC 	(C) LEFT & RIGHT PANEL 2PCS 	(D) TOP PANEL 2PCS 
(F) LEFT & RIGHT LEG 2PCS 	(H) BOTTOM GRILL (REMOVABLE) 1PC 	(J) PLASTIC DRAWER 1PC 	M5X35 8PCS 
(G) FRONT & BACK FRAME 2PCS 	(I) PLASTIC BOTTOM 1PC 	(K) LONG PERCH 1PC 	(L) PLASTIC CUP 2PCS 
		(M) WHEEL 4PCS 	



STEP 1

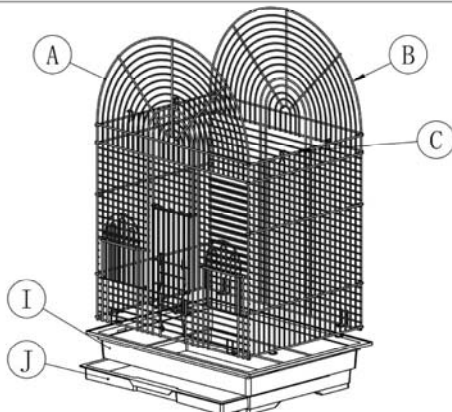

Slide plastic drawer J into part I and put the assembled cage body in the slot of plastic bottom I and buckle them by putting clips on left & right panels C in the holes of part I;

STEP 2

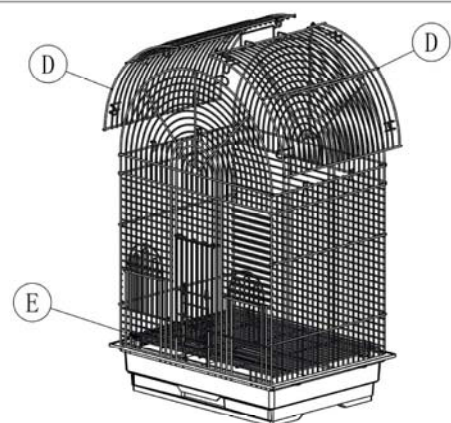

Put grill E inside the body, then buckle top panel D with front panel A, back panel B and panel C, then buckle themselves;

STEP 3

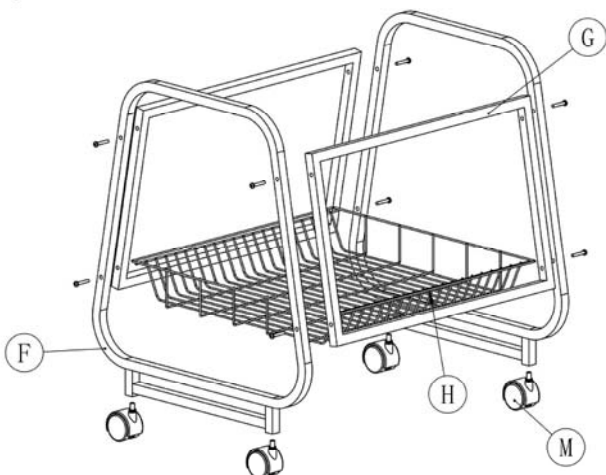

Attach left & right legs F, front & back frame G and wheels M with screws, then put bottom grill onto it;

STEP 4

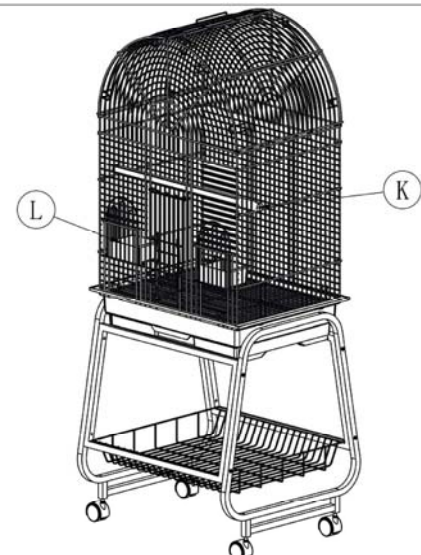

Finally put cage body on cage stand, then put plastic cup L in the access on part A & place perch K in appropriate position of the cage body.